

DA

SST

AISI 304

AISI 316

DA 120 / DA 180

Double action spring hinges prepared to work in especially harsh environments. Available in stainless steel AISI 304 and AISI 316 stainless steel, better known as "Marine Steel".

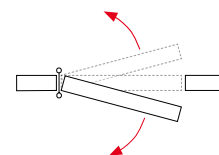

Outside materials

- blade: SST AISI 304 or AISI 316 polished
- adjustable cap and washers: SST AISI 316

Inside materials

- inner axle: SST AISI 304 or AISI 316
- inner spring: steel blades set with protective grease

Performance

- application: suitable for indoor/outdoor installation
- automatic return: yes
- adjustable return power: yes
- maximum door opening: 180°
- working cycles: up to 500.000

Proper installation of 2 and 3 hinges

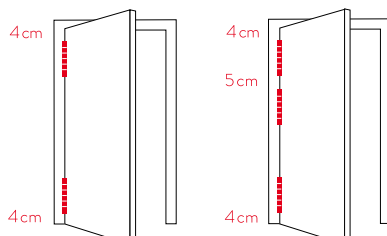

Tension

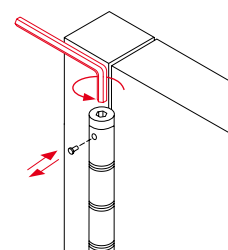

3-points adjusting cap

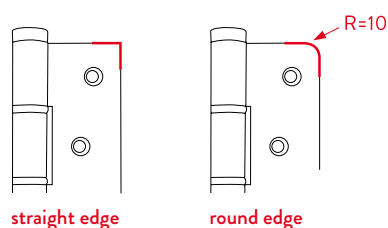

straight edge

round edge

DA 120

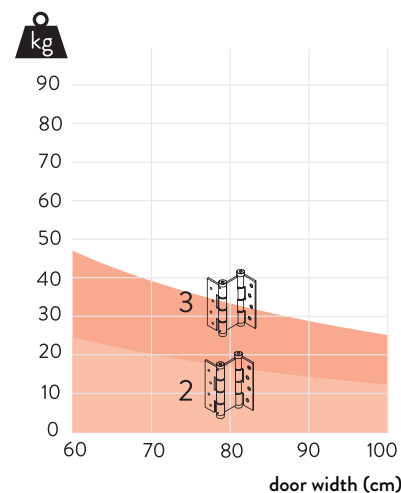
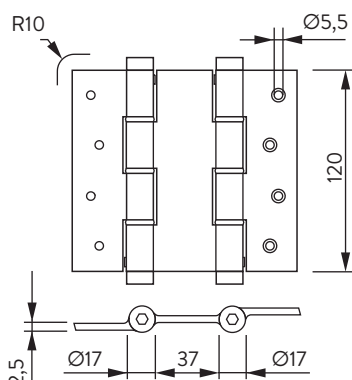
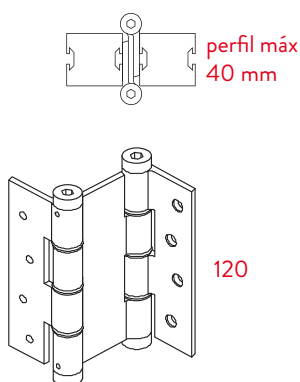

DA 180

