

DA IRON

DA 120 / DA 180

Double action spring hinges prepared for traditional installation to be fixed with screws, as well as for installation by welding on frame and door. Maximum performance even with minimum tension.

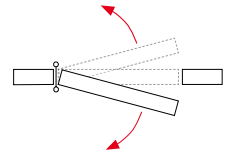

Outside materials

- blade: steel zinc-plated
- adjustable cap and washers: carbon steel

Inside materials

- inner axle: stainless steel AISI 304
- inner spring: steel blades set with protective grease

Performance

- application: suitable for indoor/outdoor installation
- automatic return: yes
- adjustable return power: yes
- maximum door opening: 180°
- working cycles: up to 500.000

Proper installation of 2 and 3 hinges

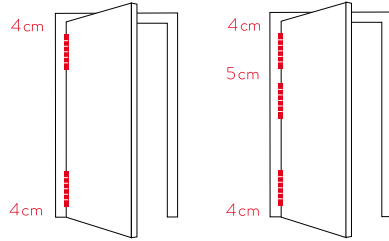

Tension

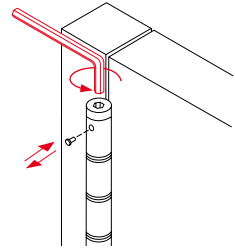

3-points adjusting cap

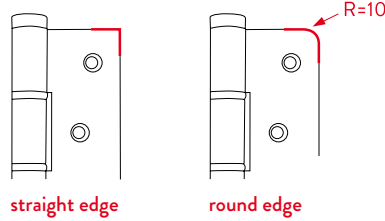

DA 120

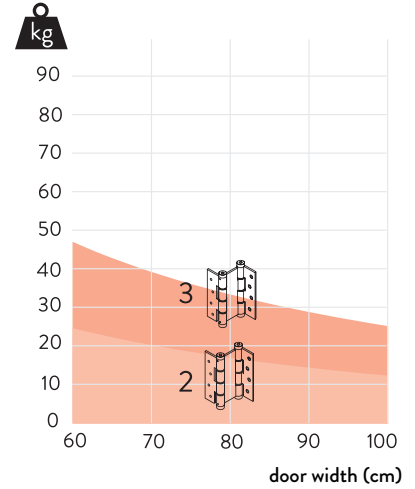
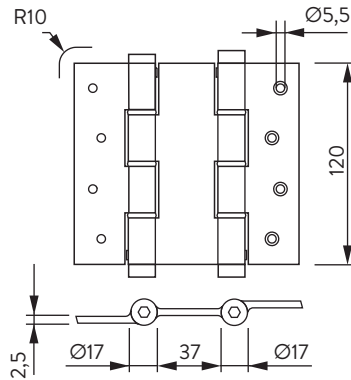
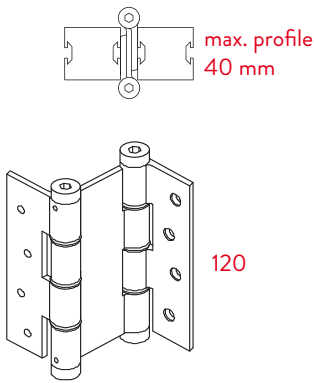

DA 180

